



# Dynamics of the matrix in DMS Type-II quantum dot systems

Collin Brown<sup>1</sup>, Vincent R. Whiteside<sup>1</sup>, Ian R. Sellers<sup>1</sup>,  
Athos Petrou<sup>2</sup>, W-C. Chou<sup>3</sup>

1 - University of Oklahoma

2 – University at Buffalo SUNY

3 – National Chiao Tung University

Work supported by NSF DMR-1305770



# Schematic



## ZnTe/(Zn,Mn)Se

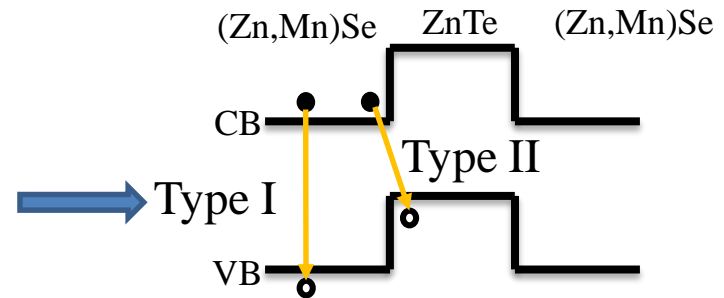
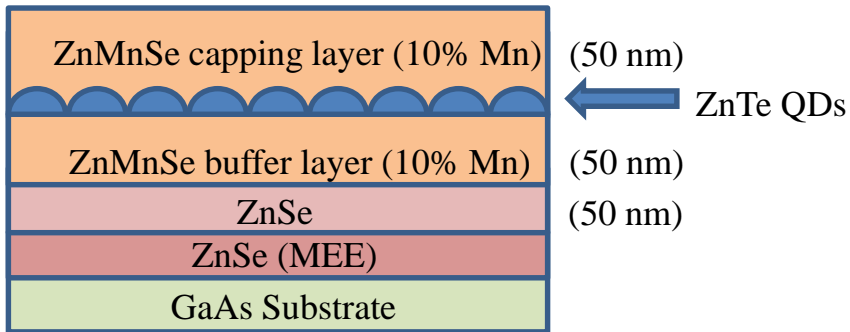

## (Zn,Mn)Te/ZnSe

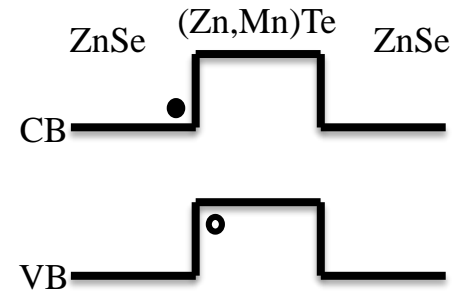
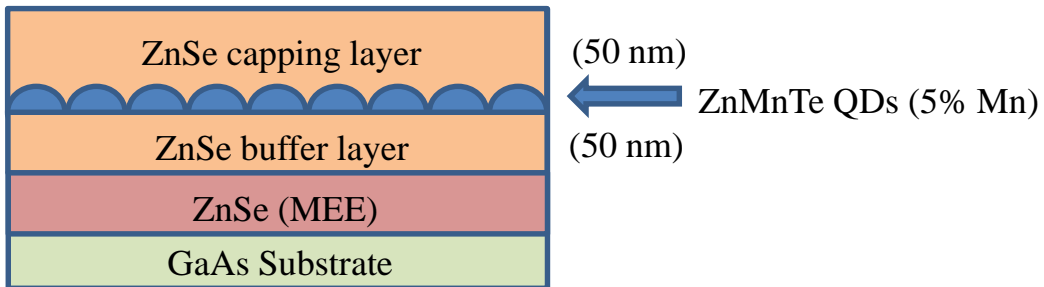



# Photolumuminescence at 4K

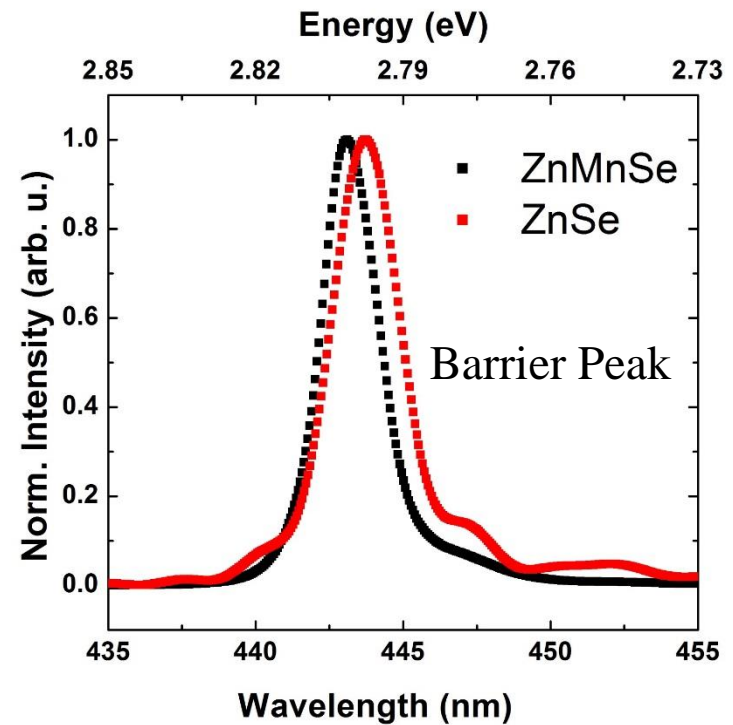
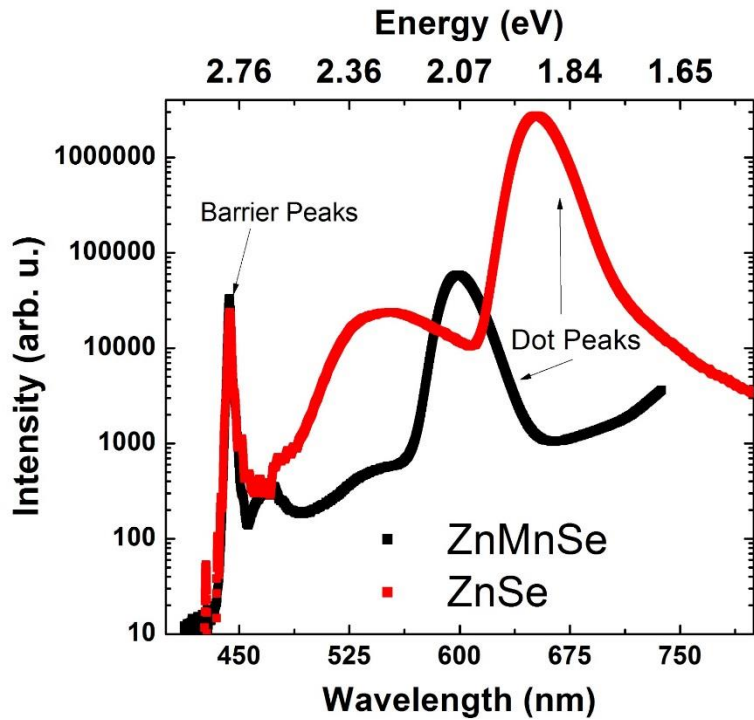

- B. Barman *et al.*, Physical Review B **92**, 035430 (2015).
- I. R. Sellers *et al.*, Physical Review B **82**, 195320 (2010).
- I. R. Sellers, V. R. Whiteside, A. O. Govorov, W. C. Fan, W. C. Chou, I. Khan, A. Petrou, and B. D. McCombe, Physical Review B **77**, 241302 (2008).

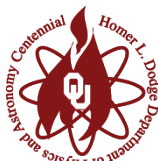

# Temperature Dependence

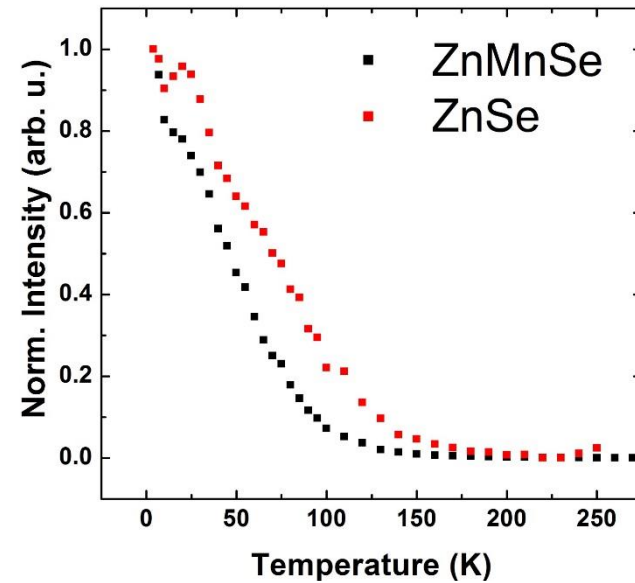
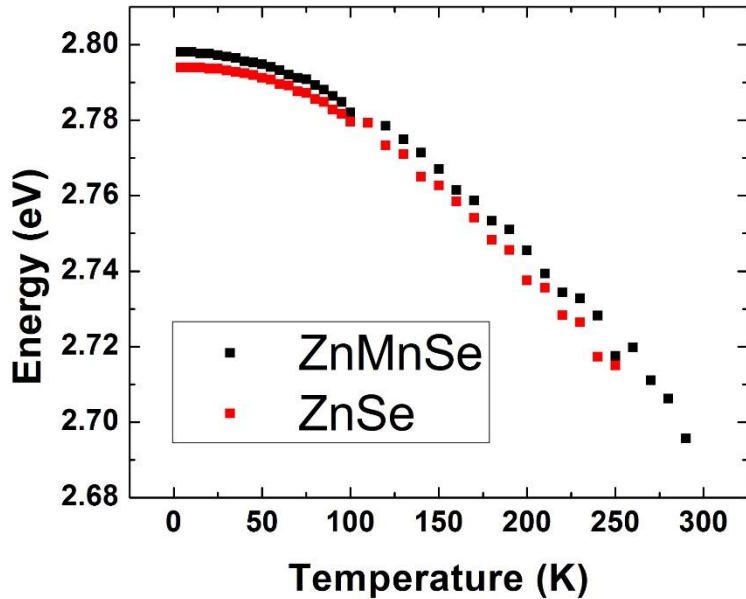

- The barrier region in both samples exhibits classic Varshni behavior due to temperature.
- Both samples also exhibit fast quenching of the photoluminescence (PL) after 25K

ZnMnSe  $E_A = 17$  meV  
ZnSe  $E_A = 14$  meV

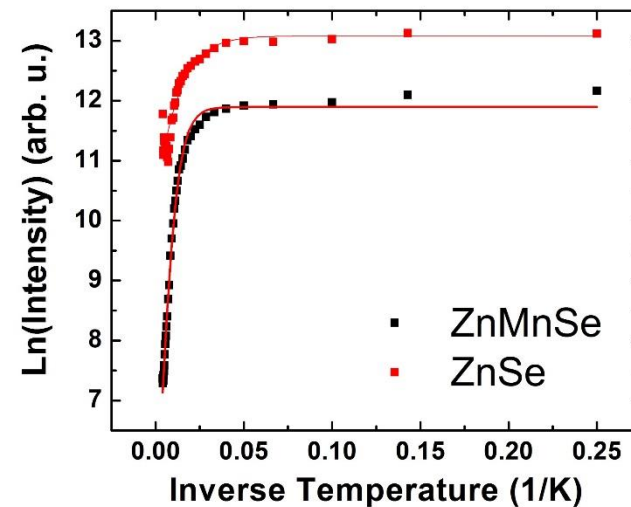



# Intensity vs Field

## ZnMnSe at 77K

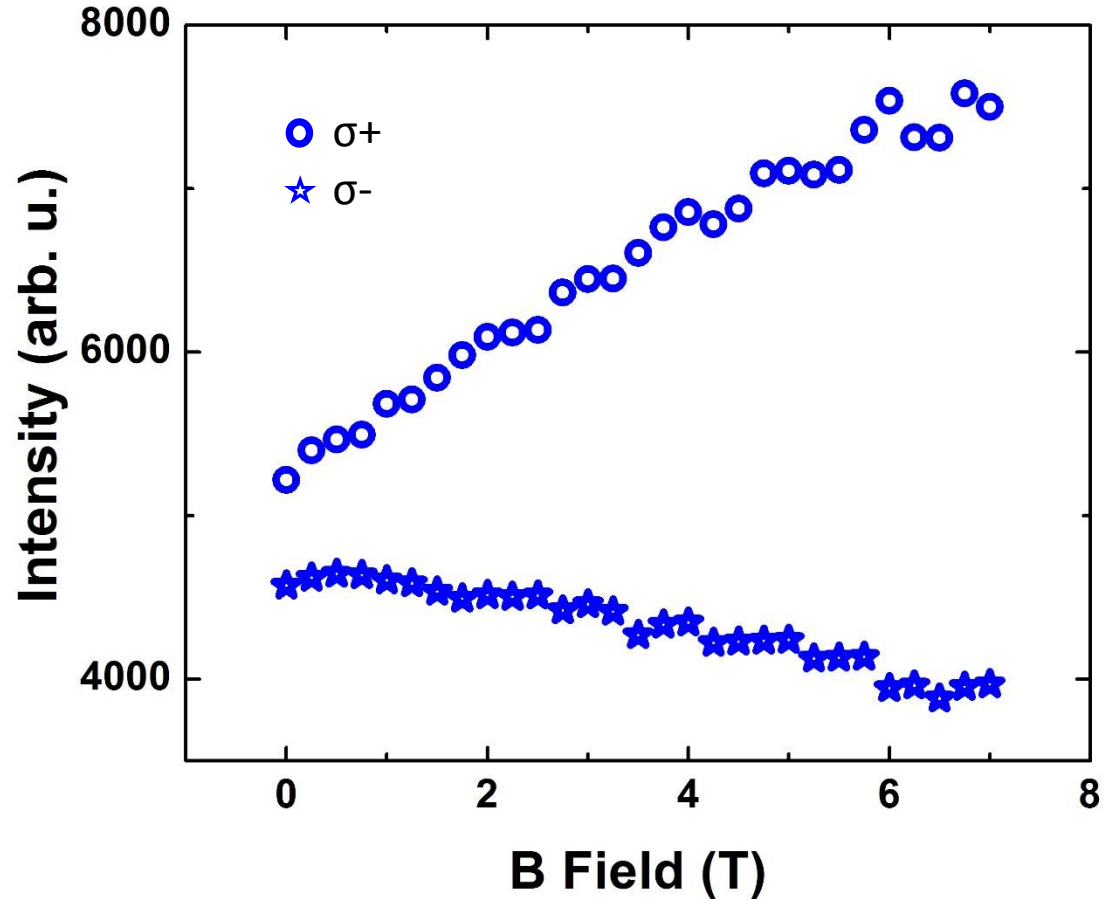
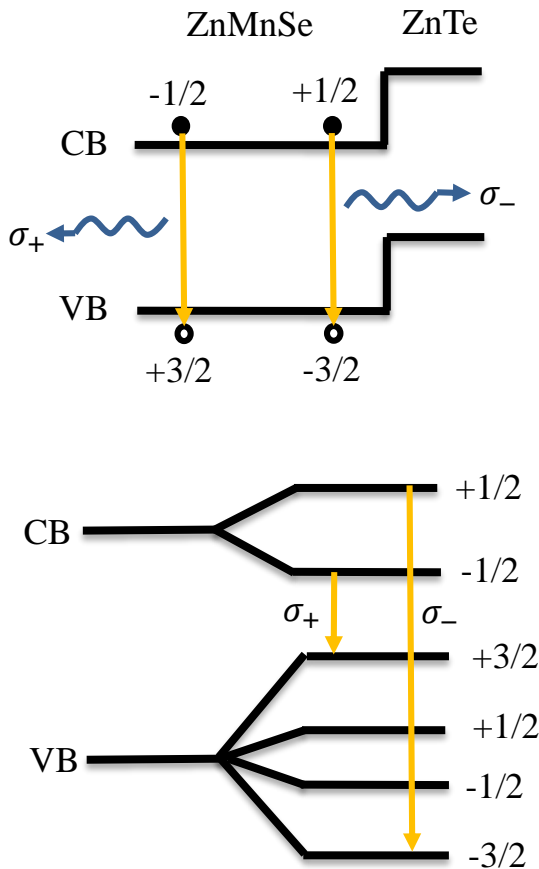

Polarization is calculated using Peak Height –  $P = \frac{|\sigma_+ - \sigma_-|}{\sigma_+ + \sigma_-} \times 100$



# Polarization



### ZnMnSe Matrix Polarization

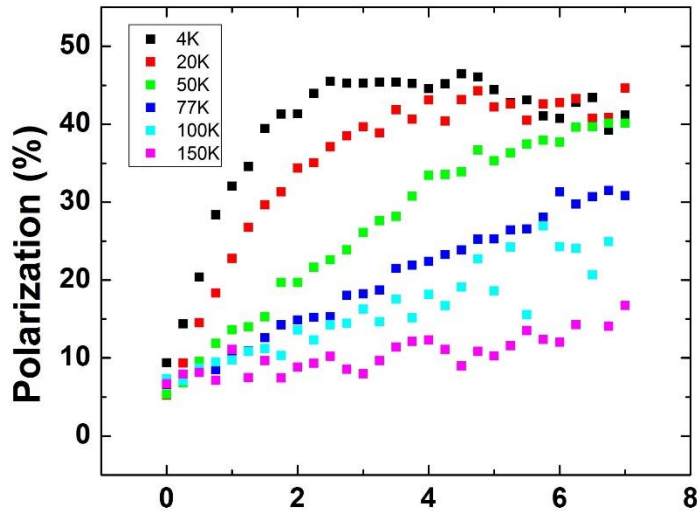

### ZnTe QD Polarization

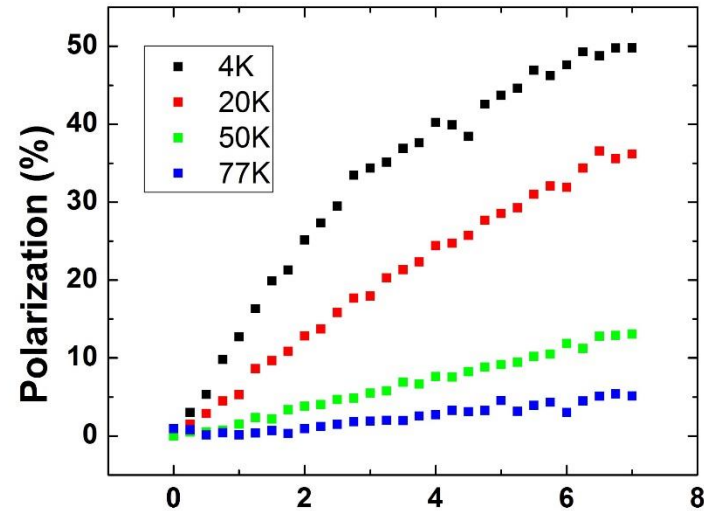

10% Mn

B. Barman *et al.*, Physical Review B **92**, 035430 (2015).

### ZnSe Matrix Polarization

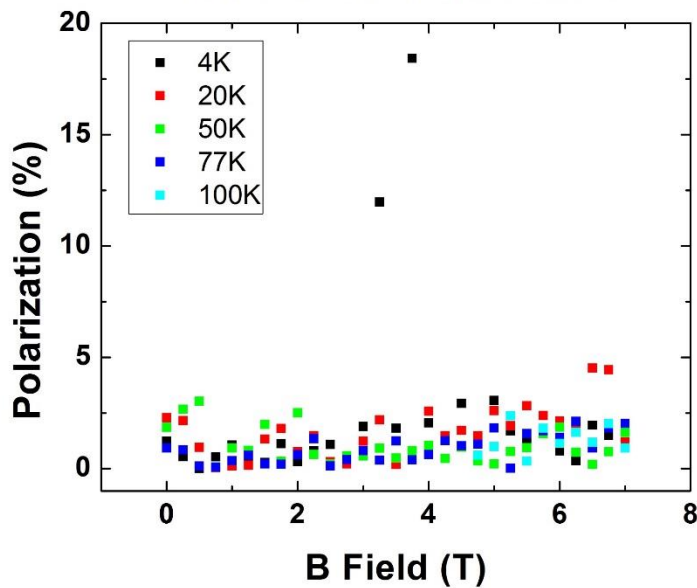

### ZnMnTe QD Polarization

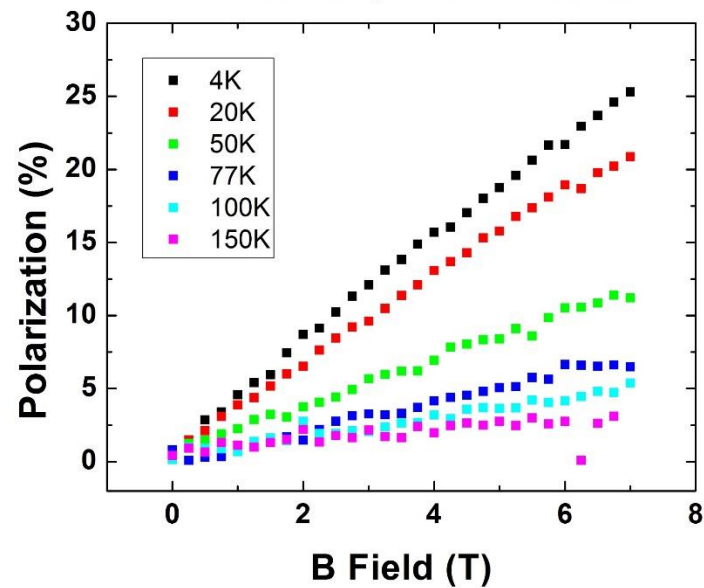

5% Mn



# Temperature Dependent Polarization

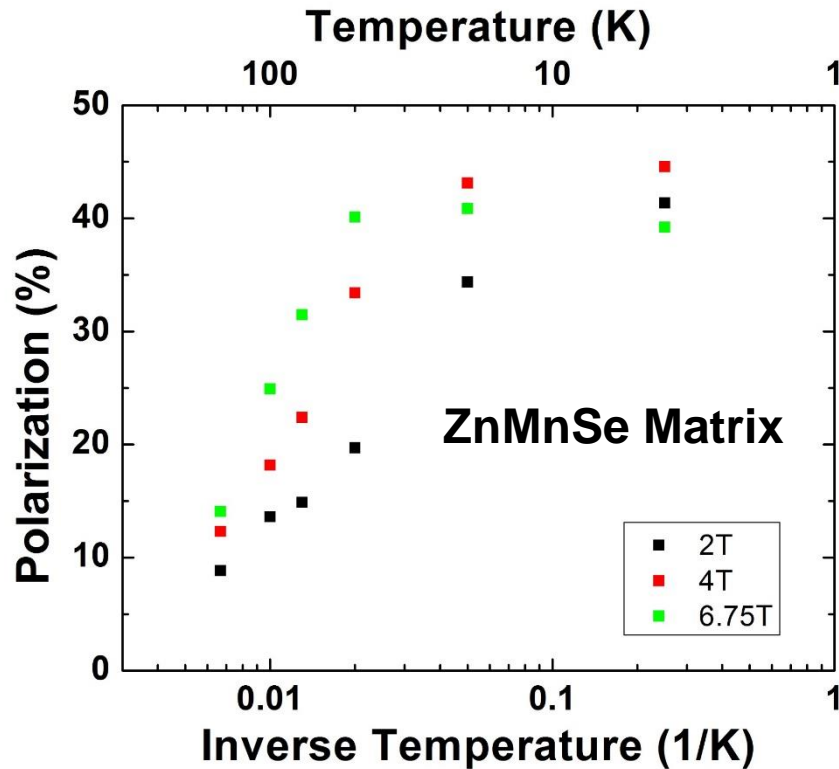

The matrix exhibits classic paramagnetism. We see increasing polarization with field, and decreasing polarization with temperature.

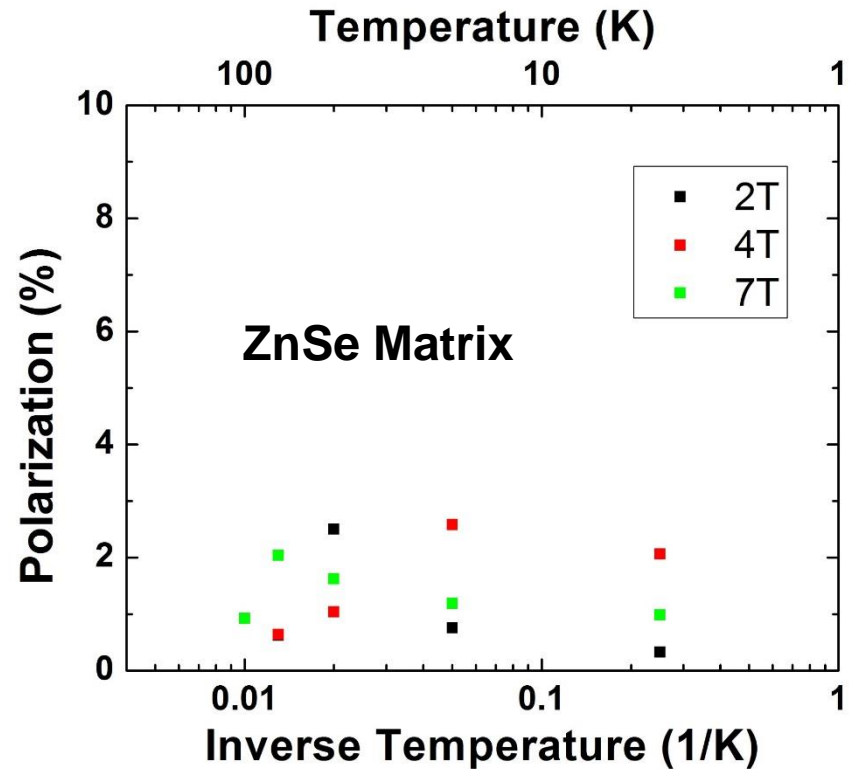

The matrix exhibits no behavior, which is normal considering there is no Mn in this Matrix.





# Zeeman Energy

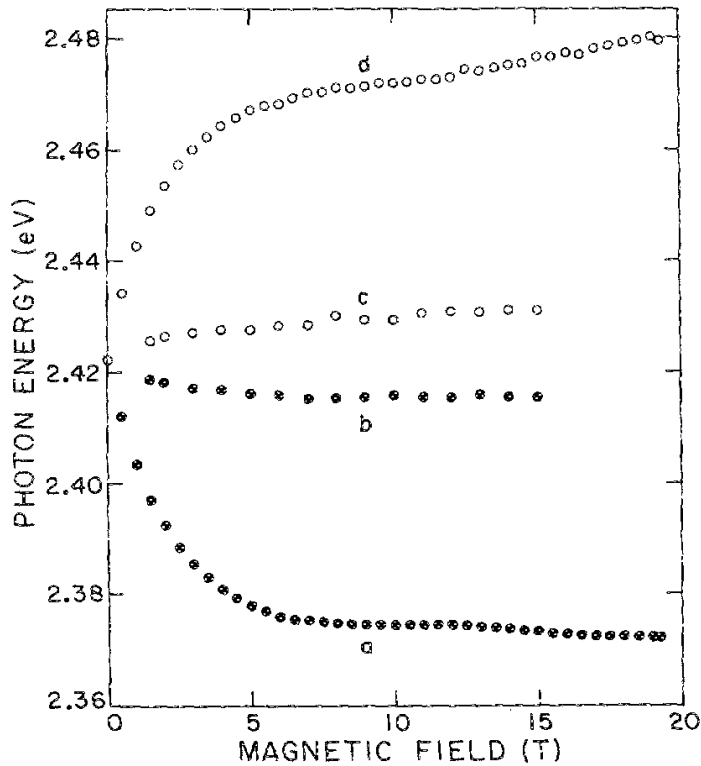

Here is the Zeeman energy behavior for a conventional paramagnet.\*

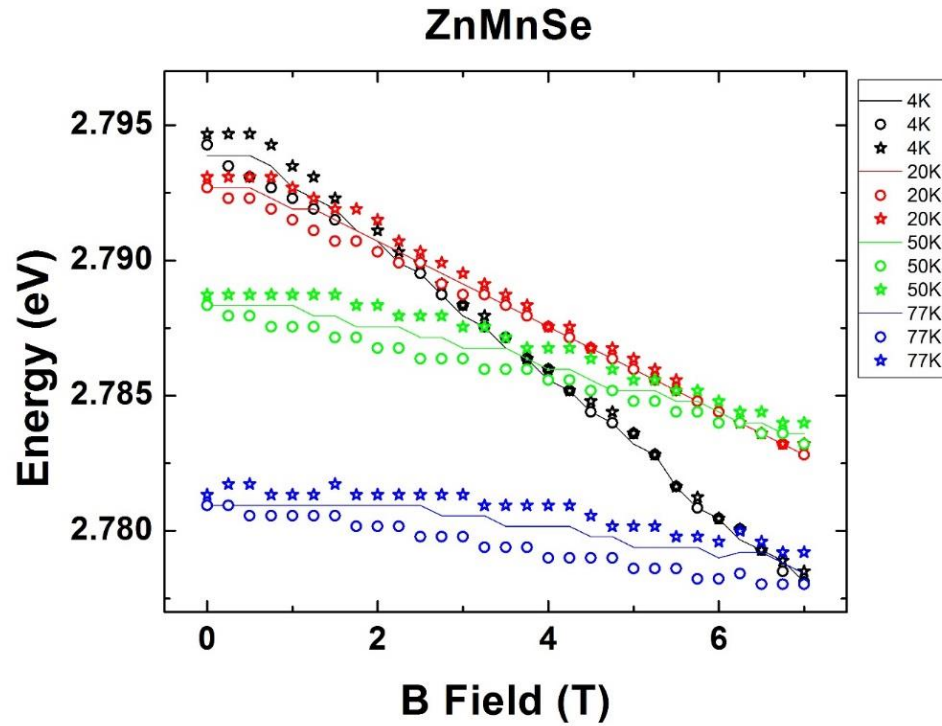

Here is what we see.

\* J. K. Furdyna, Journal of Applied Physics **64**, R29 (1988).





# Zeeman Energy Behavior



ZnMnSe

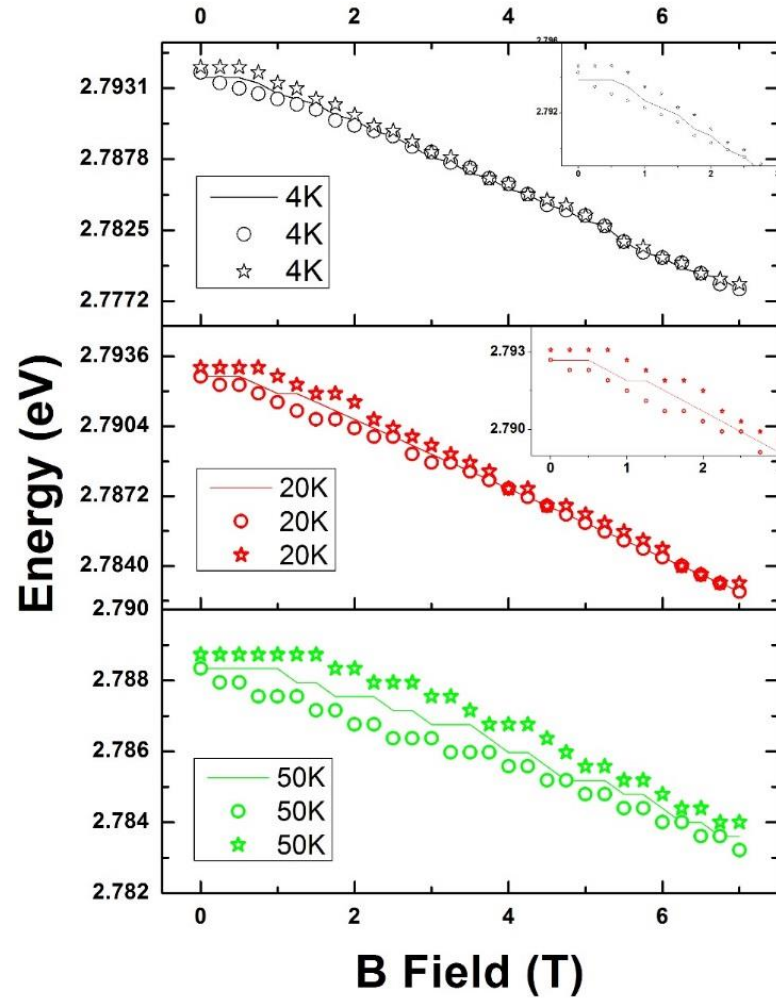
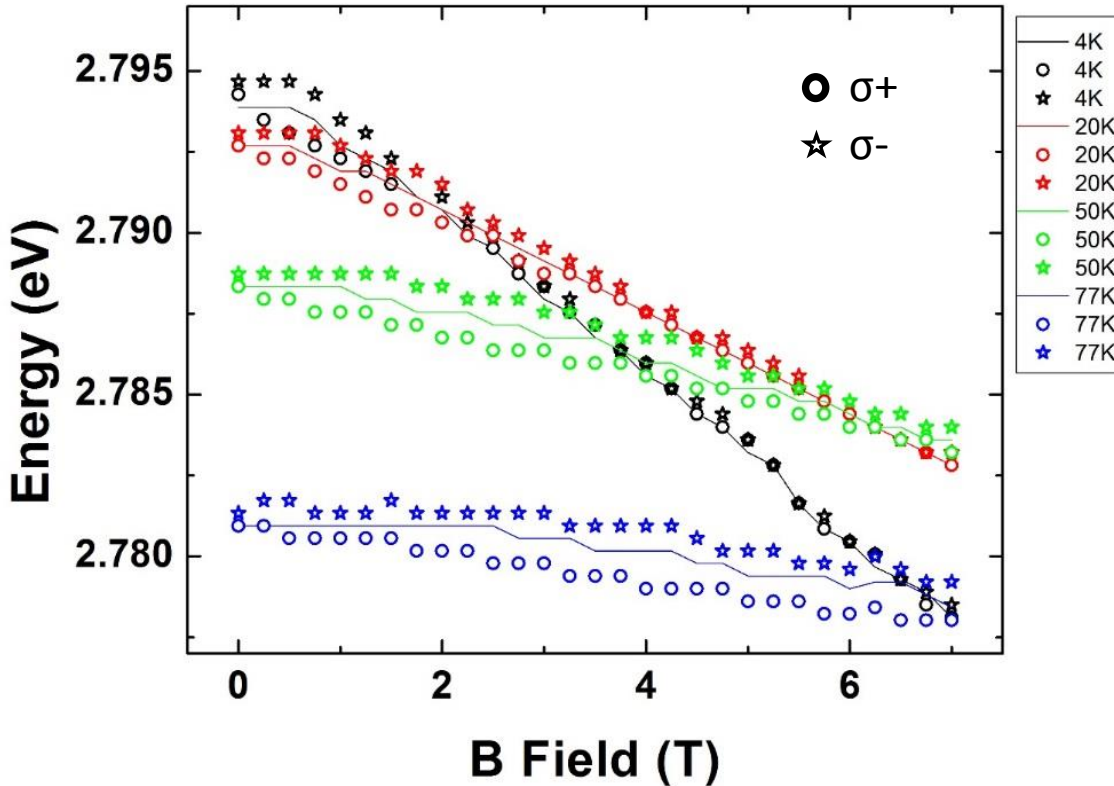



# Future Work

- Magnetorefectivity - This will help us determine whether we are really seeing  $\sigma$ -
- We will reverse the applied magnetic field to measure hysteresis in the photoluminescence spectra.
- We are collaborating with the Colorado School of Mines to understand exactly where the Mn impurities are in our samples.
  - Cross Sectional Transmission Electron Microscopy (TEM)
  - Atomic Force Topography (AFT)
  
- Questions?